



52cm Undermount Rangehood

Model Number SUM52

INSTRUCTION MANUAL

IM Version No.: V1.1

Issue Date: 04/2018

AFTER SALES SUPPORT

 1300 11 43 57

 support@residentiagroup.com.au

MODEL: SUM52 | PRODUCT CODE: 60143 | 4/2018



E2447

Welcome

Congratulations on choosing to buy a STIRLING® product.

All products brought to you by STIRLING® are manufactured to the highest standards of performance and safety and, as part of our philosophy of customer service and satisfaction, are backed by our comprehensive 3 Year In Home Warranty. We hope you will enjoy using your purchase for many years to come.

Contents

- 2 Welcome**
- 4 Warranty**
- 5 General Safety Instructions**
- 7 Product Overview**
- 9 Getting Started**
- 9 Installation**
- 12 Cleaning and Maintenance**
- 13 FAQs and Troubleshooting**
- 14 Technical Data**
- 14 Specifications**
- 15 Repair and Refurbished Goods or Parts Notice**
- 16 Warranty Returns**



STIRLING[®]

52CM UNDERMOUNT RANGEHOOD

Warranty Details

REGISTER YOUR PURCHASE AT www.aldi.com.au/en/about-aldi/product-registration/ TO KEEP UP-TO-DATE WITH IMPORTANT PRODUCT INFORMATION

The product is guaranteed to be free from defects in workmanship and parts for a period of 36 months from the date of purchase. Defects that occur within this warranty period, under normal use and care, will be repaired, replaced or refunded at our discretion. The benefits conferred by this warranty are in addition to all rights and remedies in respect of the product that the consumer has under the Competition and Consumer Act 2010 and similar state and territory laws.

Our goods come with guarantees that cannot be excluded under the Australian Consumer Law. You are entitled to a replacement or refund for a major failure and for compensation for any other reasonably foreseeable loss or damage. You are also entitled to have the goods repaired or replaced if the goods fail to be of acceptable quality and the failure does not amount to a major failure.



General Safety Instructions

IMPORTANT SAFETY INSTRUCTIONS READ CAREFULLY AND KEEP FOR FUTURE REFERENCE

Read this manual thoroughly before first use, even if you are familiar with this type of product. The safety precautions enclosed herein reduce the risk of fire, electric shock and injury when correctly adhered to. Make sure you understand all instructions and warnings.

Keep the manual in a safe place for future reference, along with the completed warranty card and purchase receipt. If you sell or transfer ownership of this product, pass on these instructions to the new owner.

Always follow basic safety precautions and accident prevention measures when using an electrical appliance, including the following:

This rangehood must only be installed in accordance with the instructions provided. Incorrect installation may cause harm to persons, damage property and void the product's warranty.

Important

Please ensure that you read the entire instructions before beginning the installation of your rangehood.

Warning

All electrical work must be done in accordance with local and national electrical codes as applicable and should be undertaken by licensed and qualified persons only.

Usage Conditions and Restrictions

- **Domestic use only:** This rangehood is designed for domestic household use only.
- **Purpose:** Do not use this rangehood for anything other than its intended purpose. Other uses are not recommended and may cause fire, electric shock or personal injury.
- **Improper use:** Damage due to improper use, or repairs made by unqualified personnel will void your warranty. We assume no liability for any eventual damages caused by misuse of the product or noncompliance with these instructions. You must read the instructions concerning the method and frequency of cleaning.

Important!

There is a risk of fire if cleaning isn't carried out in accordance with the instructions.

Electrical Safety

- **Voltage:** Before connecting and turning on the rangehood, ensure the electrical voltage and circuit frequency correspond to that indicated on the appliance rating label.
- **Earthing:** This rangehood should be properly earthed for your safety. The power cord of this rangehood is equipped with a three-prong plug for use in standard wall outlets to minimise the possibility of electrical shock. Do not modify the cord and/or plug provided with the appliance. Improper use of the earthed plug can result in the risk of electric shock.
- **Connection:** This rangehood requires a standard 220-240 V AC 50Hz electrical outlet. Do not overload the electrical circuit.
- **Power cord:** Do not kink or damage the power cord; do not leave it exposed or dangling. Keep the cord out of reach of children. When moving the appliance, make sure not to damage the power cord.
- **Auxiliary Items:** Do not use an inverter, adaptor or extension cord with this rangehood. If the cord is too short, have a qualified electrician install an outlet near the appliance. Use of an extension cord and an inverter can negatively affect the performance of the unit.
- **Protect from moisture:** To protect against the risk of electric shock, do not immerse the unit, cord or plug in water or spray it with any other liquid. Do not connect or disconnect the electric plug when your hands are wet. Turn the power switch off before removing the plug from the socket.

- **WARNING: Disconnect!** To reduce the risk of fire, electric shock or personal injury, always unplug the appliance from the socket when not in use, when moving and before cleaning or servicing. Never unplug the unit by pulling the power cord. Always grip the plug firmly and pull straight out from the power point.
- **Electrical work:** Any electrical work required for the installation of this appliance should be carried out by a qualified electrician.
- **WARNING:** Do not use mechanical devices or other means to accelerate the defrosting process, other than those recommended by the manufacturer.
- **Usage restriction:** This rangehood is not intended for use by persons (including children) with reduced physical, sensory or mental capabilities, or lack of experience and knowledge, unless they have been given supervision or instructions concerning use of the appliance by a person responsible for their safety.
- **Children:** Supervise young children to ensure they do not play with the appliance. Never allow children to operate or play with the rangehood.
- **Never:** Flambé under the rangehood
- **Damage:** Do not use the rangehood if the power cord, plug or the rangehood itself is damaged. If the cord is damaged, contact the after sales support line and have the cord replaced by qualified personnel in order to avoid a hazard.
- **Do not modify:** Do not attempt to alter or modify this rangehood in any way.
- **Repair:** Do not attempt to repair or replace any part of your rangehood unless it is specifically recommended in this manual. All other servicing should be referred to a qualified technician. Contact the after sales support line for advice.

Caution! During unpacking, the packaging materials (polythene bags, polystyrene pieces, etc.) should be kept out of reach of children.

Disposal of the appliance

Old appliances should not simply be disposed of with normal household waste, but should be delivered to a collection and recycling centre for electric and electronic equipment. A symbol shown on the product, the instruction manual or the packaging shows that it is suitable for recycling.

Materials used inside the appliance are recyclable and are labelled with information concerning this. By recycling materials or other parts from used devices you are making a significant contribution to the protection of our environment. Information on appropriate disposal centres for used devices can be provided by your local authority.

There shall be adequate ventilation of the room when the range hood is used at the same time as appliances burning gas or other fuels (not applicable to appliances that only discharge the air back into the room).

CAUTION: Accessible parts may become hot when used with cooking appliances.

Product Overview

52cm Undermount Rangehood

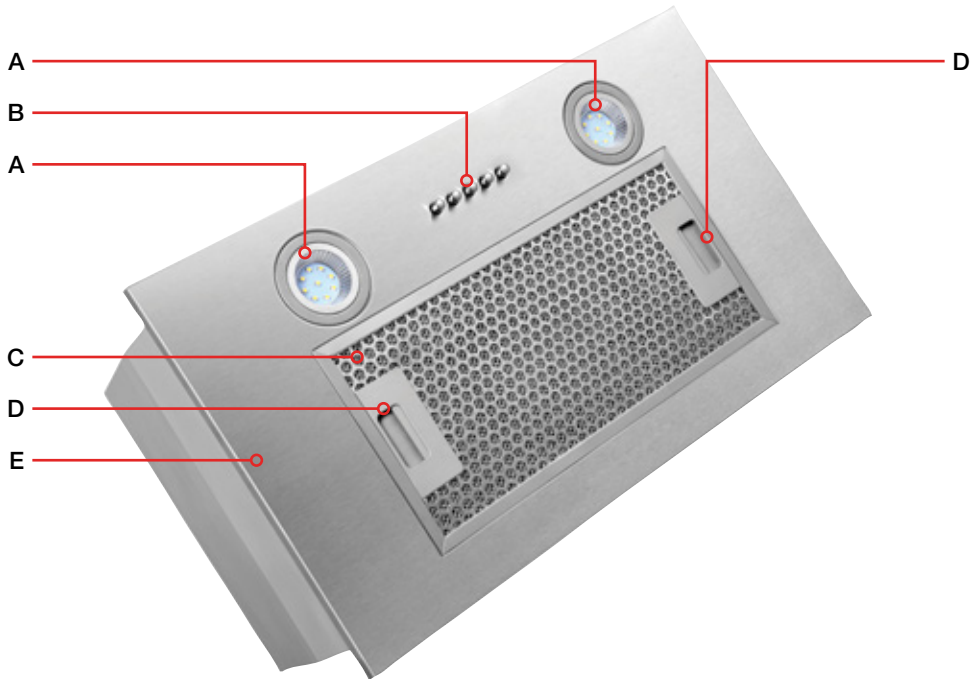

Key:

- A. LED Light
- B. Push-button Control Panel
- C. Decorative Filter
- D. Filter Handle
- E. Stainless Steel Fascia

Also included but not shown:

1 × Pack of screws

Product Overview Cont.

Control Panel Layout

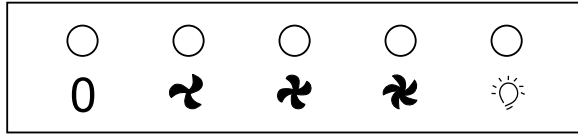

Key:



Off button

Press this button for turning the fan off.



Low Speed button

Used for ventilation on the kitchen. It is suitable for simmering and cooking which do not make much steam.



Medium Speed button

Airflow speed is ideally for ventilation in standard cooking operation.



High Speed button

When high density of smoke or steam produced, press high-speed button for highest effective ventilation.



Light button

NOTE

If Low / Medium / High speed buttons are press at the same time, the unit will only operate at the highest speed.

Getting Started

Unpacking

- **Packaging materials:** This rangehood has been packaged to protect it against transportation damage. Remove all packaging materials from around and inside the rangehood and keep the original packaging carton and materials in a safe place. It will help prevent any damage if the product needs to be transported in the future, and you can use it to store the rangehood when it is not in use. In the event the carton is to be disposed of, please recycle all packaging materials where possible.
- **Suffocation:** Plastic wrapping can be a suffocation hazard for babies and young children, so ensure all packaging materials are out of their reach and disposed of safely.
- **Power cord:** Unwind the power cord to its full length and inspect it for damage. Do not use the rangehood if it or its cord have been damaged or are not working properly. In case of damage, contact our after sales support line for advice on examination, repair or return of the damaged product.
- **Read the manual:** Read this manual to familiarise yourself with the rangehood. Pay particular attention to the safety instructions on the previous pages.
- **Clean:** To remove any dust from transit and storage, clean the interior and exterior surfaces of the rangehood with lukewarm water and a soft cloth. Dry thoroughly.

Installation

- **Two person installation:** Use two or more able-bodied people to move and install the rangehood. Failure to do so can result in back or other injury.
- **Please Note:** Stainless steel is very easily damaged during installation. Wherever possible, protect the rangehood with the cardboard box or plastic wrap during the installation.
- **Safety:** This rangehood must be earthed and always switch the power off prior to beginning the installation.

Do NOT install/use the rangehood in the following locations/situations:

- In a recreational vehicle.
- Outdoors.
- In an area with excessive moisture and high humidity. Make sure it is protected from elements such as wind, rain, water spray or drips.
- **Power:** A power point must be located within 1.5m of the power cord exit from the rangehood, and it should be always accessible to allow isolation from power during cleaning or maintenance.
- **Ducting:** All ducting must comply with building codes and local requirements.
- **Re-circulating:** Stirling does not recommend installing this rangehood as re-circulating. However if ducting is not possible, and you do choose to install your rangehood as re-circulating please ensure that the side outlet grilles are not obstructed in any way as this will effect the efficiency of the rangehood.
- **Level:** Ensure that the rangehood is mounted in a level position, both horizontally and vertically. This is essential to ensure the rangehood operates correctly and prevents grease build up at one end.

WARNING!

—
All electrical work associated with the installation of this rangehood must be carried out by a licensed electrician. This rangehood must be correctly installed by a suitably qualified person in strict accordance with all applicable rules and regulations and following the instructions in this manual.

Do not try to install the rangehood yourself; doing so will expose you to danger and void the warranty. Improper installation, adjustment, alteration or service can cause injury or damage. We decline any responsibility for injury or damage, to persons or property, as a result of improper installation.

Installation Cont.

It's important to carefully read the following installation instructions before beginning the installation of your rangehood.

Important installation safety

- Always switch the power at the mains off prior to beginning the installation.
- Stainless steel is very easily damaged during installation. Wherever possible, protect the rangehood with the cardboard box or plastic wrap during the installation.
- For safety reasons, this rangehood must be earthed.
- A power point must be located within 1.5m of the power cord exit from the rangehood, and it should be always accessible to allow isolation from power during cleaning or maintenance.
- All ducting must comply with building codes and local requirements.
- Ensure that the rangehood is mounted in a level position, both horizontally and vertically. This is essential to ensure the rangehood operates correctly and prevents grease build up at one end.

Ducting options

Before beginning the installation of your rangehood, the method of ducting should be considered and selected. The guide below illustrates the various ducting options.



Fig. 1



Fig. 2



Fig. 3

- Into your ceiling cavity and then vented through your eaves. (Fig. 1)
- Straight up and through your tiled or metal roof. (Fig. 2)
- Through your wall. (Fig. 3)

Further to your various ducting options, below are some tips on how to correctly duct your rangehood:

- Always use correctly sized ducting: **DO NOT** reduce the size of the ducting.
- Always use solid ducting.
- Always use non-flammable ducting.
- Always duct to the outside atmosphere.
- **DO NO** use flexible ducting.
- **DO NO** duct into the ceiling space: always vent to the outside atmosphere.
- Avoid sharp 90 degree bends as much as possible, use 45 degree bends instead wherever possible.
- Duct to the outside atmosphere using the shortest duct run possible.
- Use cylindrical ducting whenever possible.

Installation Cont.

Positioning the rangehood

Installation heights

- Over gas and electric cookers, this rangehood is recommended to be mounted at a height of between 600–800mm above the cooking surface.
- Electric cooktops must have a minimum height of 600mm from the underside of the rangehood to the cooktop face.
- Gas cooktops must have a minimum of 650mm from the burner to the underside of the rangehood.
- Over open flame grillers or barbecues, the Gas Regulations require the filters of the rangehood to be at least 1200mm above the cooking surface.

Installing the rangehood

The typical installation method for your undermount rangehood is into a purpose built overhead/wall cabinet.

- Using a jigsaw, create the required cut-out for your undermount rangehood: 490 × 250mm
- Make sure the cut-out is at least 35mm from the cabinet edge.

Please refer to Fig. 4 for the following points.

- Remove the grease filter and remove the 4 screws on the fascia panel.
- Screw the rangehood into the cabinet using 8 screws (supplied).
- Re-fit the fascia panel with the 4 screws (previously removed).
- Re-fit grease filter.

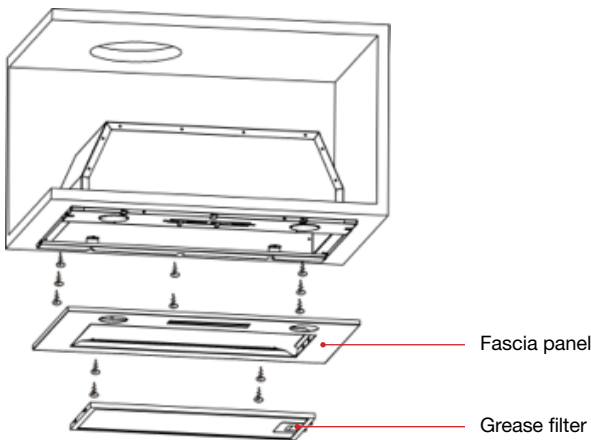

Fig. 4

Cleaning & Maintenance

By ensuring proper cleaning and maintenance of your Stirling rangehood, you can ensure that it will have a long and fault free operation.

Cleaning the grease filters

Keeping this filter clean will keep the rangehood extraction performance at an optimum. Please strictly follow the guidelines below.

- The grease filter mesh is made of high-density stainless steel. Please ensure you never use a corrosive detergent during cleaning.
- Method 1: Put the mesh into 40-50°C clean water with a small amount of regular dishwashing liquid, and soak for 2-3 mins. Wear gloves and clean with a soft brush. Please do not apply too much pressure, as the mesh is delicate and will damage easy.
- Method 2: You can wash your rangehood grease filters in your dishwasher, however please ensure they aren't washed at a temperature above 60° C degrees.

Cleaning the cooker hood

- To protect the main body of your rangehood from corrosion or stains, the cooker hood should be cleaned with hot water with a non-corrosive detergent every two months. For stubborn stains or marks, you can try using a specific stainless steel cleaner available from most supermarkets.
- **WARNING!** Please do not use a corrosive detergent, or abrasive clothes, as it will damage the body.
- Keep the motor and other spare parts free from water, as this will cause damage to the appliance.
- Before cleaning the rangehood, always switch the power off at the outlet and unplug the rangehood.
- If your rangehood has a damaged plug or cord, please ensure your rangehood remains unplugged and contact the Residentia Support team for further assistance. Any electrical work should only be completed by a suitably licenced and authorised person.
- If you're using a carbon filter, it should never be exposed to heat.

Changing a light globe

In the event of a blown globe:

- Disconnect the rangehood from the power supply.
- Press the lamp cover and take out the globe in a counter clockwise direction. (Fig. 5)
- After replacing the bulb, re-install the lamp cover, turning in a clockwise direction.

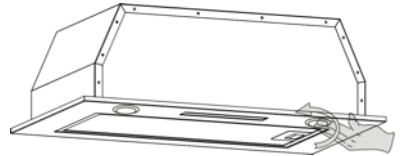

Fig. 5

Carbon filter (optional)

An optional carbon filter can be purchased separately and installed in your undermount rangehood. Normally the activated carbon filter should be changed every three to six months according to your volume of cooking. Activated carbon filter cannot be washed or recycled. The installation procedure of activated carbon filter is as below.

- Remove the grease filters.
- Insert the first activated carbon filter into the unit and turn it in anti-clockwise direction. Then repeat the same on the other side. (Fig. 6)
- Re-insert the grease filters.

Note: When the activated carbon filter installed, the suction power will be lowered.



Fig. 6

FAQs & Troubleshooting

Operation in case of emergency

In the event of an emergency you should:

- Switch off all rangehood controls.
- Switch the rangehood off at the power outlet and immediately unplug.
- Call After Sales Support on 1300 11 HELP (4357).

Some minor faults can be fixed by referring to the instructions given in the Troubleshooting section below.

Important!

If your appliance appears to be operating incorrectly, then you should disconnect it from your electrical supply and then contact After Sales Support on 1300 11 HELP (4357).

Warning!

Do not attempt to repair the rangehood yourself.







Please note that if an engineer is asked to attend whilst the product is under warranty and finds that the problem is not the result of an appliance fault, then you may be liable for the cost of the call out charge.

The appliance must be accessible for the engineer to perform any necessary repair. If your appliance is installed in such a way that an engineer is concerned that damage will be caused to the appliance or your kitchen, then they will not complete a repair. This includes situations where the rangehood has been tiled in or sealed in with a sealant.

Please refer to the conditions of that appear on the warranty card at the rear of this user manual.

Fault	Common Cause	Common Solutions
The lights work, however the motor does not work.	The motor is blocked or jammed.	Call After Sales Support for further guidance.
	The capacitor is damaged.	Call After Sales Support for further guidance.
Neither the lights or the motor works.	Beside the above mentioned, check the following:	
	Light globes are damaged or blown	Call After Sales Support for further guidance.
	The power cord is loose.	Ensure that the rangehood is correctly plugged in and the power outlet is switched on.
The rangehood is vibrating against the wall.	The rangehood canopy is not fixed to the wall correctly.	Ensure that the internal safety screws have been used and are tight.
Insufficient suction.	The distance between the rangehood and your cooktop is too great.	Have your installer re-adjust the installation position, ensuring that the minimum distances are observed as per the building code.

Technical Data

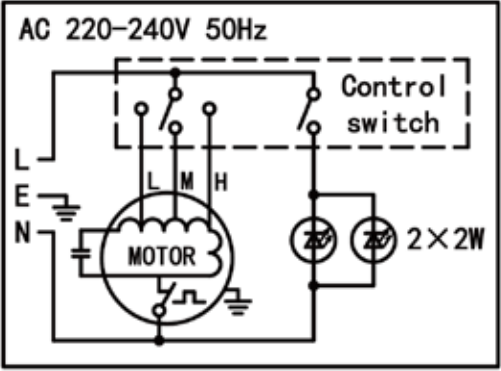
	52cm Undermount Rangehood	
	Model: SUM52	Volts/Hz: 220-240V 50Hz
Light: 2 x 2W	Motor: 1 x 210W	Total: 214W
S/N: Global Mark Certification and Authorized Mark Number: GMA-103109-EA-001		
  		
Residentia Group PTY LTD Made in: China 04/2018 Barcode: 2632 9451 PLU: 60143 V1.1		
 (AUS) 1300 11 4357  support@residentiagroup.com.au		
		

Specifications

Model	Extraction	Other features:
SUM52	750m ³ /hr extraction	<ul style="list-style-type: none"> • 3 speed push button control • 2 x 2W LED Lamp • 1 x 5 layer aluminium grease filter with s/steel Facia

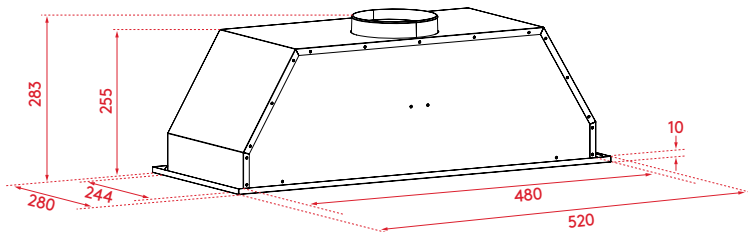



 **STIRLING**[®]

52CM UNDERMOUNT RANGEHOOD

Repair and Refurbished Goods or Parts Notice

Unfortunately, from time to time, faulty products are manufactured which need to be returned to the Supplier for repair.

Please be aware that if your product is capable of retaining user-generated data (such as files stored on a computer hard drive, telephone numbers stored on a mobile telephone, songs stored on a portable media player, games saved on a games console or files stored on a USB memory stick) during the process of repair, some or all of your stored data may be lost.

We recommend you save this data elsewhere prior to sending the product for repair.

You should also be aware that rather than repairing goods, we may replace them with refurbished goods of the same type or use refurbished parts in the repair process.

Please be assured though, refurbished parts or replacements are only used where they meet ALDI's stringent quality specifications.

If at any time you feel your repair is being handled unsatisfactorily, you may escalate your complaint. Please telephone us on 1300 11 43 57 or write to us at:

Residentia Group
118 Campbell Street
Collingwood VIC 3066
Australia

Email: support@residentiagroup.com.au

Helpline hours of operation:
Mon–Fri
9:00 AM - 5:00 PM



Warranty returns

Should you for any reason need to return this product for a warranty claim, make sure to include all accessories with the product.

Product does not work?

If you encounter problems with this product, or if it fails to perform to your expectations, make sure to contact our After Sales Support Centre on 1300 11 4357 before returning it to the store for a refund.

For an electronic copy of this manual, go to www.stirlingappliances.com.au and download a copy.

