



Steam Mop

Model Number SM-102

INSTRUCTION MANUAL

IM Version No: V1.3

Issue Date: 18 December 2014

AFTER SALES SUPPORT
☎ (AUS) 1300 886 649

📧 info@tempo.org
MODEL: SM-102 PRODUCT CODE: 48711 03/2015



Welcome

Congratulations on choosing to buy a Stirling® product.

All products brought to you by Stirling® are manufactured to the highest standards of performance and safety and, as part of our philosophy of customer service and satisfaction, are backed by our comprehensive 3 Year Warranty. We hope you will enjoy using your purchase for many years to come.

Contents

- 02 Welcome**
- 04 Warranty Details**
- 05 General Safety Instructions**
- 08 Product Overview**
- 09 Getting Started**
- 12 Features**
- 13 Instructions**
- 15 FAQs**
- 16 Other Useful Information**
- 19 Repair and Refurbished Goods or Parts Notice**



STIRLING[®]

Steam Mop

Warranty Details

The product is guaranteed to be free from defects in workmanship and parts for a period of 36 months from the date of purchase. Defects that occur within this warranty period, under normal use and care, will be repaired, replaced or refunded at our discretion, solely at our option with no charge for parts and labour. The benefits conferred by this warranty are in addition to all rights and remedies in respect of the product that the consumer has under the Competition and Consumer Act 2010 and similar state and territory laws.

Our goods come with guarantees that cannot be excluded under the Australian Consumer Law. You are entitled to a replacement or refund for a major failure and to compensation for any other reasonably foreseeable loss or damage. You are also entitled to have the goods repaired or replaced if the goods fail to be of acceptable quality and the failure does not amount to a major failure.



General Safety Instructions

IMPORTANT SAFETY INSTRUCTIONS

READ CAREFULLY AND KEEP FOR FUTURE REFERENCE

Read this manual thoroughly before first use, even if you are familiar with this type of product. The safety precautions enclosed herein reduce the risk of fire, electric shock and injury when correctly adhered to.

Keep the manual in a safe place for future reference, along with the completed warranty card, purchase receipt and carton. If applicable, pass these instructions on to the next owner of the appliance.

Always follow basic safety precautions and accident prevention measures when using an electrical appliance, including the following:

Electrical safety and cord handling

- **Voltage:** Make sure your outlet voltage and circuit frequency correspond to the voltage stated on the product rating label and your wall socket is earthed.
- **No extension cord:** Do not use an extension cord or electrical outlet with inadequate current-carrying capacity.
- **Water:** To protect against fire and electric shock, do not immerse the cord, plug or the appliance itself in water or other liquid, or expose the electrical connections to water or other liquid. Keep it away from water; do not allow it to get wet. If the product is wet, do not plug it into a wall socket or turn it on. Do not handle the steam mop with wet hands.
- **Power cord:** Do not kink, squash or damage the cord and protect it from sharp edges and heat. Do not let it touch hot surfaces. Do not pull or carry the mop by the cord; do not close a door on the cord. Run the cord in such a way that there will be no risk of anyone pulling it inadvertently or tripping over it.
- **Do not use if damaged:** Check the appliance and cord before every use to ensure that it is undamaged and safe to operate. Do not pick up or operate the appliance if the power supply cord, plug or housing is damaged. **Do not use the appliance after it malfunctions or has been dropped or damaged in any manner, or if it has been left outside or dropped into water.**
- **RCD:** Unless your home is already fitted with a residual current device, we recommend installing a safety switch with a rated residual operating current not exceeding 30mA to provide additional safety protection when using electrical appliances. See your electrician for professional advice.
- **Damaged cord:** A damaged cord or plug must be replaced by the manufacturer or a qualified person in order to avoid a hazard. In case of damage, contact our after sales support centre for advice.

General Safety Instructions (Cont.)

- **Unattended:** Do not leave the product unattended while plugged in; unplug it from the power outlet when it is not in use.
- **Disconnect:** Unplug the product before changing accessories, moving or cleaning it. Switch off the power at the outlet and then gently pull on the plug to unplug it. Do not pull on the cord.

Usage conditions and restrictions

- **Household use only:** This appliance is intended for household use only. Do not use the product outdoors. Do not use steam for space heating purposes.
- **Intended use:** This product is intended for cleaning floors in a domestic environment. Do not use it for anything other than its intended purpose, and only use it as described in these operating instructions.
- **Accessories:** Only use the appliance with the accessories provided. Improper installation and the use of accessories that are not specifically recommended may result in fire, electric shock, personal injury and/or damage to the unit.
- **Children:** This appliance is not a toy; make sure children do not play with it. Cleaning and user maintenance shall not be made by children unless they are older than 8 and supervised. Keep the appliance and its cord out of reach of children younger than 8 years. Close attention is necessary when using the product near children.
- **Usage restriction:** This appliance can be used by children aged from 8 years and above and persons with reduced physical, sensory or mental capabilities or lack of experience and knowledge IF they have been given supervision or instruction concerning use of the appliance in a safe way and understand the hazards involved.
- **Liability:** We assume no liability for any eventual damages due to improper use or incorrect handling, or noncompliance with these instructions.
- **Safe usage:** Ensure that all the parts are correctly assembled before operation. **Do not use the steam mop without the floor cloth in place. Do not use it without water in the water tank.**
- **Changing accessories:** Always unplug the device from the power point before changing accessories.
- **Water use:** Fill the water tank only with tap water, or with distilled or demineralised water, if you live in a hard water area. Do not use detergents or other cleaning or descaling agents in the steam mop because these can damage the product.

General Safety Instructions (Cont.)

- **Do not block openings:** Never stick any objects in the openings. Do not use the device if the openings are blocked. Keep the steam opening free of lint, hair, and the like.
- **Use with caution:** When using the steam mop, watch out for third parties, especially children. Keep pets out of the way when using the steam mop. Do not direct steam at people, animals, plants and equipment containing electrical components. Do not clean over floor electrical outlets.
- **Work area:** Keep your work area well lit. Use extra care when cleaning on stairs. Do not rest the appliance on stairs when it is not in use.
- **Cleaning pads:** Only use the steam mop with a cleaning pad attached.
- **Do not incline:** When operating, never turn the steam mop over or use while on its side. Always use it on a flat surface to avoid overturning.
- **Storage:** After use, store the appliance indoors in a cool, dry place. Do not store it with a wet mop still attached.
- **Do not modify:** Never remove parts (such as screws, etc.) from the appliance. Otherwise, you may risk damaging the unit and voiding your warranty. **In case of damage or malfunction, contact our after sales support centre for advice.**
- **Repairs and service:** All repairs and service work, including replacing the power cord, may only be conducted by an authorised electrician. It is hazardous for anyone other than a competent person to carry out any service or repair operation that involves the removal of a cover which gives protection against exposure to electrical parts.

CAUTION: HOT STEAM!

To avoid scalding and burns, take extra care when using the steam mop.

- The high temperatures generated by the steam mop can cause injuries and burns. Avoid skin contact with the appliance during use.
- Never point the steam mop at persons, pets or plants, and only use it on surfaces or objects that can withstand high temperatures.
- Do not open the filling aperture during use.
- After use, allow the steam mop sufficient time to cool before removing the cleaning pad.

Product Overview

- 1 Handle
- 2 Trigger switch
- 3 Upper cord wrap hook
- 4 Cord guide
- 5 Carry handle
- 6 Handle fastening screw (not visible here)
- 7 800mL Water tank
- 8 Body
- 9 Power indicator
- 10 Head fastening screw (not visible here)
- 11 Triangular steam head
- 12 180° Swivel connector
- 13 Microfibre cloth pads
- 14 Measuring cup
- 15 Carpet glider
- 16 Steam opening (at the underside of the mop head)

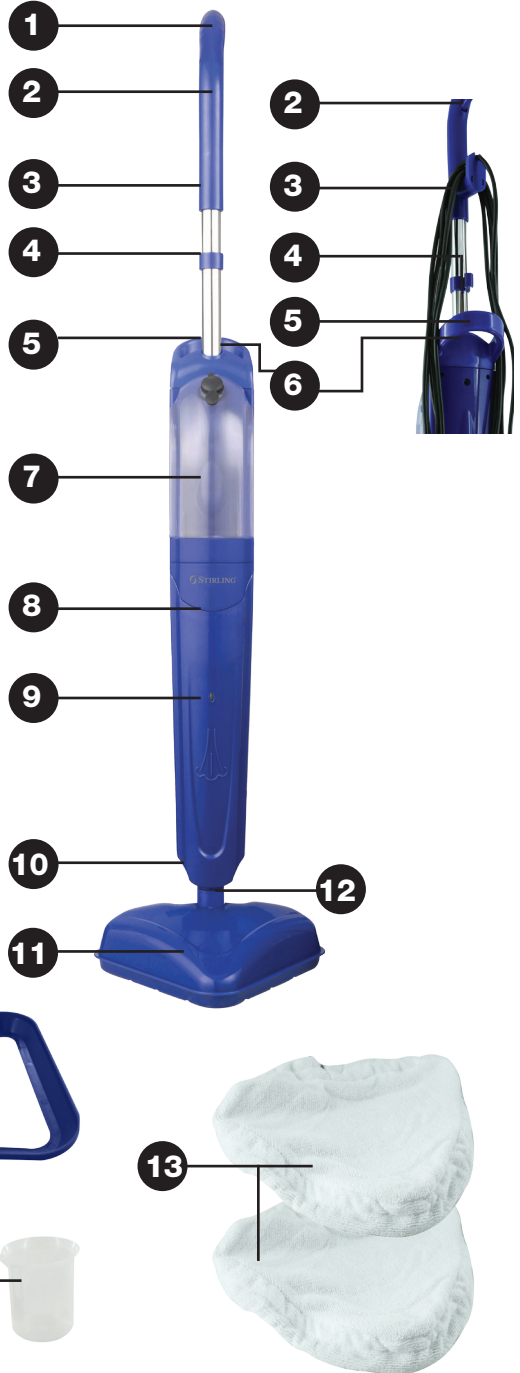

Getting Started

Unpacking

- This product has been packaged to protect it against transportation damage. Unpack the appliance but keep all packaging materials until you have assembled your new steam mop and have made sure it is undamaged and in good working order. The carton is recyclable. Whenever possible, reuse the carton and recycle it when disposing of the packaging materials.
- Plastic wrapping can be a suffocation hazard for babies and young children, so ensure all packaging materials are out of their reach. Dispose of any plastic wrapping safely.

CAUTION!

The screws for fastening the steam head and handle to the appliance come packaged in a small plastic bag inside the measuring cup and cloth pads.
Take care not to lose the screws when unpacking!

- Make sure you have all the parts listed on the opposite page.
- Inspect the steam mop for visual damage such as misaligned or damaged parts, damage to the main body and separate components.
- Unwind the cord to its full length and inspect the cord and plug for damage.
- Do not use the appliance if the appliance or its cord have been damaged or are not working properly. **In case of damage, contact our after sales support line for advice.**
- Read this manual to familiarise yourself with all the parts and operating principles of the steam mop. Pay particular attention to the safety instructions on the previous pages.
- Before assembly, make sure the steam mop is disconnected from the power supply.

Getting Started (Cont.)

Steam mop assembly

In addition to the parts supplied, you will need a Phillips head screwdriver to assemble the steam mop.

1. Attach the triangular steam head to the body of the steam mop and secure it tightly with the small head fastening screw, as illustrated below (Fig. 1).

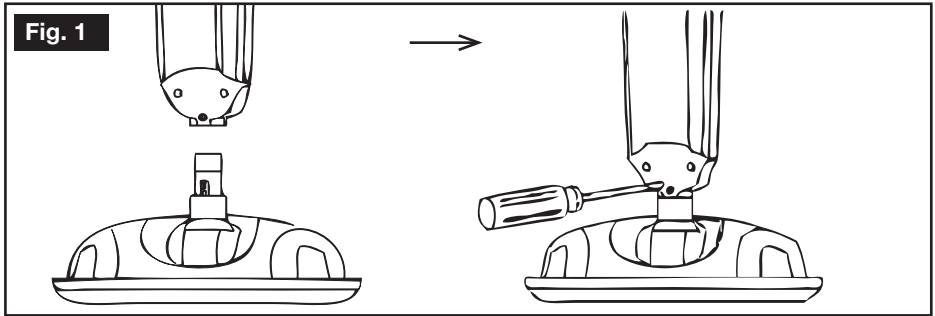

2. Following the illustrations below, insert the handle into the body of the steam mop (Fig. 2). Make sure to insert it fully so the screw hole in the handle is aligned with the screw hole in the body of the appliance.

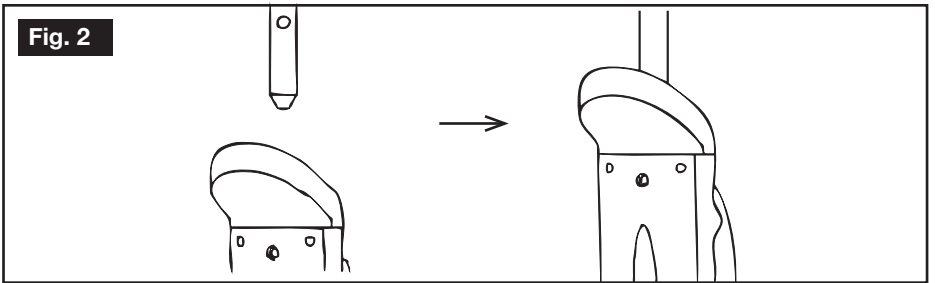

3. Secure the handle tightly with the large handle fastening screw and washer, (Fig.3), then position the handle ring on the handle, as illustrated below (Fig.4).

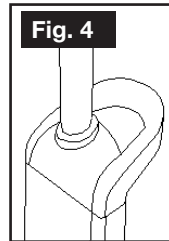
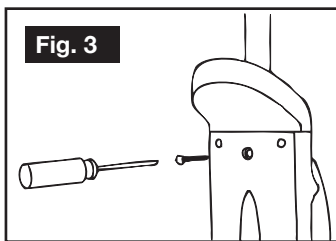

Getting Started (Cont.)

- Place the microfibre cloth pad onto the triangular steam head, as illustrated below (Fig. 5). Pull the cord while pressing on the toggle to fasten the pad. Release the toggle when the pad sits tightly around the steam head.

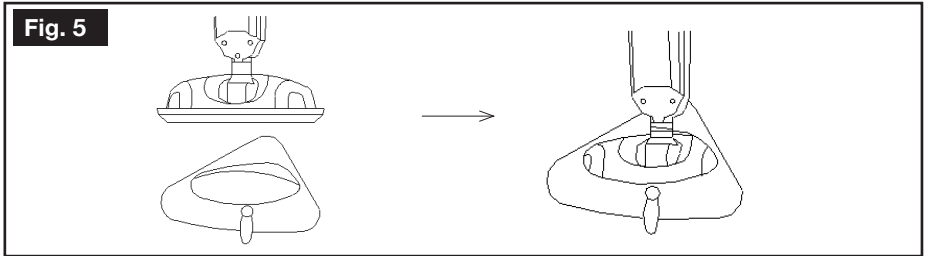

- When using the steam mop on carpet, place the triangular steam head (with the cloth wrapped around it) over the carpet glider, as illustrated below (Fig. 6).

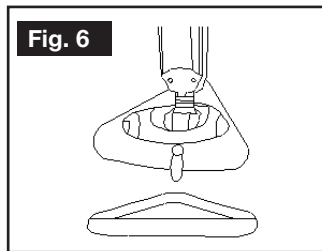

- Fill the tank with fresh tap water, as illustrated below (Fig. 7). Either detach the tank from the body (push the tank up to remove and slide filled tank back in from the top to reattach it), or use the measuring cup to fill the tank. The tank holds 800mL. **Do not overfill past the MAX marking**, leave some room for the water to expand.

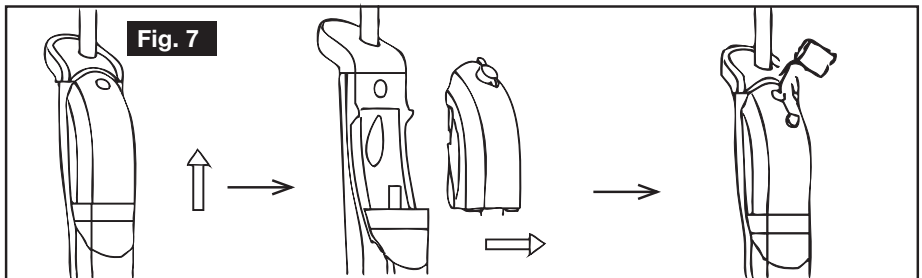

CAUTION!

Always ensure the unit is unplugged from the electrical outlet before filling or refilling the water tank.

Features

The easy, environmentally friendly way to clean your floors

- **No chemicals**
Thoroughly cleans and sanitises floor surfaces without any chemicals.
- **No elbow grease**
Easily removes dirt and grime from hard floors or carpets, leaving them hygienically clean without the need for hard physical labour.
- **Tap water only**
Designed for use with tap water that will be converted into steam. (Distilled or demineralised water is recommended for use in hard water areas.)
- **Triangular steam head**
Designed with a triangular steam head and a 180° swivel connector for effortless cleaning of surfaces right into corners.
- **Reusable cloths**
Comes with two reusable, highly absorbent microfibre cloths that can be machine-washed in hot water and tumble dried.
- **Use on most hard floors**
Designed for use on hard surfaces that will withstand high heat, including ceramic tiles, marble, stone or linoleum floors and on sealed hardwood or parquet flooring — but see the cautions below.
- **Use on carpet and rugs**
Designed for use with the supplied carpet glider on colourfast carpet and rugs that will withstand high heat.

CAUTION!

- **Do not** use the steam mop on unsealed wood floors.
- **Do not** let the steam mop stand on any wood floor for an extended period of time. This could cause the wood grain to expand. Test an isolated area of the surface to be cleaned before proceeding.
- **Take extra care** when using the steam mop on surfaces that have been treated with wax, as the heat and steam may remove the wax or the sheen.
- **Take extra care** when using the steam mop on vinyl, linoleum or any other heat-sensitive floors, as too much heat can melt the glue in the flooring. We recommend cleaning a small sample first in an inconspicuous area of the floor and checking the floor manufacturer's use and care instructions for the surface to ensure suitability for steam-cleaning.

Instructions

Before you use the steam mop

Before you start steam-cleaning your floors, make sure that:

- The surfaces to be steam-cleaned have been swept or vacuumed.
- The steam mop is fully assembled (see pages 10-11 for instructions).
- The microfibre cloth sits tightly around the triangular steam head.
Do not use the mop without the microfibre cloth pad.
- The water tank is filled.
Do not add cleaning solutions. Only use tap water, or distilled or demineralised water if you live in a hard water area.
Do not fill beyond the maximum marking.

Steam-cleaning hard floors and refreshing carpets

1. **Prepare cord:** If the cord is wrapped around the hooks, twist the top hook clockwise for a quick release of the supply cord. Make sure the cord is completely unwound.

Push the cord into the cord guide so it does not get in the way during cleaning, as illustrated on the right (Fig. 8).

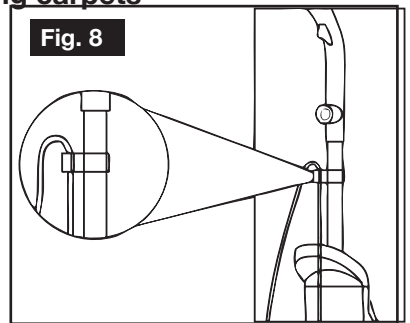

2. **Plug in:** Insert the plug into a properly earthed electrical outlet and switch on power at the outlet.

CAUTION: Do not operate another high wattage product on the same circuit to avoid overloading your electrical circuit.

Once the appliance is plugged in, the power indicator will illuminate red and the steam mop will start heating the water. After a heat-up time of approximately 15-30 seconds, when the power indicator changes to green, it will be ready to emit steam.

3. **Steam-clean:** To start releasing steam, press the trigger switch; press it again to stop releasing steam.

To steam-clean the floor, slowly pass over the surface to be cleaned in a forward and backward or sideways motion. For more intensive cleaning, leave the steam mop over the area for a few seconds (see page 14).

Instructions (Cont.)

- 7. Sanitise:** To sanitise a specific area of a hard floor surface, position the steam mop over the area for a minimum of 8 seconds, **but no longer than 15 seconds**. The steam temperature will reach approximately 90-110°C. This is particular useful for cleaning the bathroom, shower, pet sleeping area or around garbage bins.
- NOTE:** Leaving the steam mop in a stationary position for a longer period is not recommended, as this may cause the build-up of a pale residue. Should this happen, try removing the residue with a descaling product or with a few drops of vinegar (see page 15 for more on this).
- 8. Refill:** The steam mop will stop emitting steam when the tank is empty. To continue steam-cleaning, proceed as follows:
After approximately 20-30 minutes of use, press the trigger switch to stop releasing steam and disconnect the power plug from the electrical outlet.
Refill the water tank as described under point 6 on page 11.
After refilling the water tank, plug the steam mop in again, press the trigger switch to start releasing steam and continue cleaning.
- 9. Finish:** When you have finished steam-cleaning your floor, unplug the power cord from the outlet and empty the water tank.
- CAUTION:** The cloth pad may still be very hot, take care to avoid scalding.
When the cloth pad has cooled down, carefully remove it from the steam head. It can be washed in warm or hot water (and may be tumble dried).
Wind the power cord around the cord wrap hooks and store the steam mop upright in a dry area, out of children's reach.

WARNING!

- Never run the steam mop without water or without cloth pad.
- Never direct steam at a person or animal.
- When using the steam mop on a hard floor, ensure the surface can withstand high heat.
- Wet floors are slippery! Take care to avoid accidents and injury.

Troubleshooting guide

If you encounter problems with your steam mop, check in this section for solutions. If none of those offered help you solve the problem, contact our after sales support centre using the details on the bottom of the page.

PROBLEM	POSSIBLE CAUSE AND SOLUTION
Difficulty attaching/removing the cleaning pad	<ul style="list-style-type: none"> • Lay the cleaning pad on the floor. Lift the steam mop head and place it onto the pad, then use the strap to tighten it around the mop head. • To remove the mop pad, use the toggle to loosen the strap, then place your foot on the edge of the pad and lift away the steam mop.
Difficulty attaching the carpet glider	<ul style="list-style-type: none"> • Lift the mop and place the head into the side of the carpet glider that has space for the mop head. • The mop head rests in the glider and does not click into place.
No power indicator	<ul style="list-style-type: none"> • Ensure the power plug is fully inserted in the electrical outlet. • Ensure the power outlet is working properly; try it with another appliance or try operating the steam mop from a different outlet. • Ensure your home circuit breaker is operational.
No steam release	<ul style="list-style-type: none"> • Ensure the water tank is filled with water. • Ensure the water tank is securely installed on the body of the steam mop.
Pale residue on the floor after using the steam mop	<ul style="list-style-type: none"> • Leaving the steam mop in the same position for too long may have caused this. The residue can be removed with a few drops of white household vinegar or a descaling product (according to the instructions on the product). • Alternatively, redo the area with the steam mop for one minute to remove the residue, but take care not to overheat the area.
Mop not picking up dirt	<ul style="list-style-type: none"> • Change the microfibre cloth pad if it is saturated. Take care, it will be hot.

Other Useful Information

Cleaning and maintenance

WARNING!

- Before cleaning the appliance or carrying out any maintenance tasks, make sure the unit is unplugged from the electrical outlet and has cooled down completely.
- Never immerse the steam mop in water or other liquid.
- Do not use flammable substances such as alcohol, benzene or paint thinner for cleaning any part of the steam mop.

Cleaning the steam mop and accessories

- If the exterior of the unit needs to be cleaned, use a slightly damp, soft cloth and mild detergent to wipe it down and then dry it with a soft cloth.
- When wiping the main body, do not allow moisture in the area around the power indicator light.
- The microfibre cloth pads are reusable and may be machine-washed in warm or hot water and tumble dried.
- Should there be any loose threads on the microfibre pads, carefully cut the threads with scissors; do not try to pull any threads or cut them at the base.
- For replacement cloth pads, contact our after sales support centre using the details on the bottom of the page.

Service and repair

If the steam mop is damaged, **do not attempt to repair it yourself**. Contact our after sales support centre to arrange for examination or repair of the product.

Spare parts

The following spare parts are available for purchase from our after sales support centre. To purchase a spare part, call the centre on **1300 886 649** or email us at **info@tempo.org**

- Water tank
- Triangular mop head with swivel
- Handle with on/off switch
- Microfibre cleaning pads
- Carpet glider
- Measuring cup
- Steam head fastening screw

Other Useful Information (Cont.)

Technical specifications

Voltage	220-240V
Power	1500W
Steam heat-up time	15-30 seconds
Operating time	30 minutes
Liquid ingress protection	IPX4
Water tank capacity	800mL
Weight (fully assembled, with dry microfibre cloth, tank empty)	2.82kg
Dimensions (fully assembled, with handle and steam mop head)	1180cm (H) x 29.6cm (L) x 21.7cm (W)
Mop head	180° rotational
Power cord length	8m
Overheat protection	✓
Handle	Detachable
On/off switch	On the handle
Accessories supplied	2x Microfibre cloth pads, washable
	1x Measuring cup
	1x Carpet glider

This product complies with AS/NZS 60335.2.54:2010 for electrical safety standards and with EN 55014:2006+A1:2009 for electromagnetic compatibility.

Responsible disposal

At the end of its working life, do not throw this appliance out with your household rubbish. Electrical and electronic products contain substances that can have a detrimental effect on the environment and human health if disposed of inappropriately. Observe any local regulations regarding the disposal of electrical consumer goods and dispose of it appropriately for recycling. Contact your local authorities for advice on recycling facilities in your area.

This page has been left blank intentionally.



STIRLING[®]

Steam Mop

Repair and Refurbished Goods or Parts Notice

Unfortunately, from time to time, faulty products are manufactured which need to be returned to the supplier for repair.

Please be aware that if your product is capable of retaining user-generated data (such as files stored on a computer hard drive, telephone numbers stored on a mobile telephone, songs stored on a portable media player, games saved on a games console or files stored on a USB memory stick) during the process of repair, some or all of your stored data may be lost. **We recommend you save this data elsewhere prior to sending the product for repair.**

You should also be aware that rather than repairing goods, we may replace them with refurbished goods of the same type or use refurbished parts in the repair process.

Please be assured though, refurbished parts or replacements are only used where they meet ALDI's stringent quality specifications.

If at any time you feel your repair is being handled unsatisfactorily, you may escalate your complaint. Please telephone us on 1300 886 649 or write to us at:

Tempo (Aust) Pty Ltd ABN 70 106 100 252
PO BOX 6056 Frenchs Forest, Sydney, Australia NSW 2086
Telephone: 1300 886 649 (Aust) - Fax: (02) 9975 2688
Tempo Help Desk: 1300 886 649 (Aust)
(Operating Hours: Mon-Fri 08:30am to 06:00pm EST)
Email: info@tempo.org





Warranty returns

Should you for any reason need to return this product for a warranty claim, make sure to include all accessories with the product.

Product does not work?

If you encounter problems with this product, or if it fails to perform to your expectations, make sure to contact our After Sales Support Centre on 1300 886 649 before returning it to the store for a refund.

For an electronic copy of this manual, go to www.stirlingappliances.com.au and download a copy.

Instruction Manual Revision Index

Version No	Issue Date	Description
V1.0	01 December 2014	Original release
V1.1	08 December 2014	Minor updates
V1.2	11 December 2014	Compliance updates
V1.3	18 December 2014	Steam opening illustration amended on page 8