



129L Bar Fridge

Model Number STR-H129W

INSTRUCTION MANUAL

IM Version No: V1.2

Issue Date: 03 August 2015

AFTER SALES SUPPORT

  1300 886 649

 info@tempo.org

MODEL: STR-H129W PRODUCT CODE: 51272 10/2015



Welcome

Congratulations on choosing to buy a STIRLING® product.

All products brought to you by STIRLING® are manufactured to the highest standards of performance and safety and, as part of our philosophy of customer service and satisfaction, are backed by our comprehensive 3 Year Warranty. We hope you will enjoy using your purchase for many years to come.

Contents

- 02 Welcome**
- 04 Warranty Details**
- 05 General Safety Instructions**
- 08 Product Overview**
- 09 Getting Started**
- 11 Instructions**
- 14 FAQs and Troubleshooting Guide**
- 15 Other Useful Information**
- 23 Repair and Refurbished Goods or Parts Notice**



STIRLING[®]

129L Bar Fridge

Warranty Details

The product is guaranteed to be free from defects in workmanship and parts for a period of 36 months from the date of purchase. Defects that occur within this warranty period, under normal use and care, will be repaired, replaced or refunded at our discretion, solely at our option with no charge for parts and labour. The benefits conferred by this warranty are in addition to all rights and remedies in respect of the product that the consumer has under the Competition and Consumer Act 2010 and similar state and territory laws.

Our goods come with guarantees that cannot be excluded under the Australian Consumer Law. You are entitled to a replacement or refund for a major failure and to compensation for any other reasonably foreseeable loss or damage. You are also entitled to have the goods repaired or replaced if the goods fail to be of acceptable quality and the failure does not amount to a major failure.



General Safety Instructions

IMPORTANT SAFETY INSTRUCTIONS

READ CAREFULLY AND KEEP FOR FUTURE REFERENCE

Read this manual thoroughly before first use, even if you are familiar with this type of product. The safety precautions enclosed herein reduce the risk of fire, electric shock and injury when correctly adhered to. **Keep the manual in a safe place for future reference**, along with the completed warranty card, purchase receipt and carton. If applicable, pass these instructions on to the next owner of the appliance.



Pay particular attention to messages that follow this safety alert symbol or the words **DANGER, WARNING** or **CAUTION**. These words are used to alert you to a potential hazard that can seriously injure you and others. The instructions will tell you how to reduce the chance of injury and let you know what can happen if the instructions are not followed.



WARNING: Risk of fire

This symbol alerts you to take care as the appliance contains flammable materials: isobutane as refrigerant and cyclopentane as insulation blowing gas. Do not expose it to high heat, sparks and open flames.

The refrigerant isobutane (R600a) is contained within the refrigerant circuit of the appliance, a gas with a high level of environmental compatibility, which is nevertheless flammable. During transportation and installation of the appliance, ensure that none of the components of the refrigerant circuit become damaged.

WARNING: Do not damage the refrigerant circuit! Never use an appliance with a damaged refrigerant circuit! If the refrigerant circuit becomes damaged, avoid proximity to open fires and all types of heat and ignition sources. Thoroughly ventilate the room in which the appliance is located.

It is hazardous for anyone other than an authorised service person to service this appliance. In Queensland, the authorised service person **MUST** hold a Gas Work Authorisation for hydrocarbon refrigerants to carry out servicing or repairs which involve the removal of covers.

The room for installing the appliance must be at least 1m³ per 8g of refrigerant. The amount and type of refrigerant in the appliance can be found in the Technical Specifications on page 20 and on the appliance rating plate.

General Safety Instructions (Cont.)

To reduce the risk of fire, electric shock or injury, always follow basic safety precautions and accident prevention measures when using this appliance, including the following:

Installation

- **Heavy:** This appliance is heavy, take care when moving it. To avoid back or other injury, consider a two person lift or mechanical aid when installing it. Failure to do so can result in back or other injury.
- **Damage:** When unpacking, check the appliance carefully for damage. If it is damaged, do not install the appliance. Contact our after sales support centre for advice on examination or return of the damaged appliance.
- **Protect from moisture:** Install the appliance in an indoor area protected from wind, rain, water spray or drips.
- **Protect from heat:** Do not install it next to an oven, grill or other source of high heat, or where it will be exposed to direct sunlight for prolonged periods of time.
- **WARNING: Ventilation:** To ensure proper ventilation, keep any ventilation openings, in the appliance enclosure or in the built-in structure, clear of obstructions. Ensure adequate air circulation around the appliance to prevent overheating.
- **Level:** Install the appliance level in order to ensure proper operation.

Electrical safety

- **Voltage:** Plug the appliance in a 220-240V, 50Hz, properly earthed power outlet, which must be in good working order. Make sure your outlet voltage and circuit frequency correspond to the voltage stated on the appliance rating label.
- **Power connection:** Do not use an adaptor; do not use an extension cord. Plug the power plug directly into a separate power point that cannot easily be turned off accidentally, and that is easily accessible so you can switch it off when required.
- **Power cord:** Do not kink or damage the power supply cord. Do not leave it exposed or dangling. Secure it behind the appliance so no one steps on or places anything on the power supply cord or against it. A squashed or damaged power plug may overheat and cause a fire.
- **Damaged cord:** Do not use a cord that shows cracks or abrasion damage along its length or at either end. Any damage to the cord may cause a short circuit, fire and/or electric shock. If the power cord is damaged, it must be replaced by the manufacturer or its service agent. Contact the after sales support line for advice.
- **WARNING!** The **light bulb** supplied with this appliance is a special use bulb, which is only suitable for use with this appliance, it is not usable for domestic lighting. Do not operate the appliance without the lamp installed. Do not touch the light bulb if it has been on for a long period of time, as it could be very hot.
- **Disconnection:** Never unplug the unit by pulling the cord. Always grip the plug firmly and pull straight out from the power point.
- **Electrical work:** If the installation of this appliance requires any electrical work, make sure it is carried out by a qualified electrician.

General Safety Instructions (Cont.)

Usage conditions and restrictions

- **Indoor domestic use only:** This appliance is intended for indoor domestic use only, which includes use in households, staff kitchen areas in shops, offices, in farm houses and in other working environments, use by clients in hotels, motels, bed and breakfast establishments, other residential type environments and in catering and similar non-retail applications. It is not suitable for industrial or commercial use.
- **Intended purpose:** Do not use this appliance for anything other than its intended purpose, and only use it as described in this manual. Do not attempt to alter or modify this appliance in any way.
- **Usage restrictions:** The appliance can be used by children aged from 8 years and above, and persons with reduced physical, sensory or mental capabilities, or lack of experience and knowledge, if they have been given supervision or instruction concerning use of the appliance in a safe way and understand the hazards involved.
- **Children:** Supervise children to ensure they do not play with the appliance. Never allow children to operate, play with or crawl inside the appliance. Cleaning and user maintenance shall not be made by children unless they are aged from 8 years and above and supervised.
- **WARNING!** Do not use any **electrical appliances** (such as ice cream makers) inside refrigeration appliances, unless they are approved for this purpose by the manufacturer.

Cleaning and maintenance

- **Disconnect:** Unplug the appliance before cleaning or servicing. Failure to do so can result in electric shock, injury or death. Do not connect or disconnect the plug when your hands are wet.
- **Flames:** Do not let open flames or ignition sources enter the appliance.
- **Flammable/explosive substances:** Never clean this appliance with flammable fluids. Do not store or use volatile, flammable or explosive propellants or liquids in or close to this or any other appliance. The fumes can create a fire hazard or explosion.
- **Solvents:** Do not use solvent based cleaning agents or abrasives on the interior as these may damage or discolour the surfaces of the appliances.
- **WARNING!** Do not use **mechanical devices** or other means to accelerate the defrosting process. Never use a sharp or metal instrument to remove frost or clean the appliance. Use a plastic scraper, if necessary.
- **Service:** Do not attempt to repair, modify or replace any part of the appliance unless specifically recommended in this manual. Refer all other servicing to a qualified technician, or contact the after sales support line for advice on examination or repair of the appliance.

Product Overview



Scope of delivery

A Parts list

- 1 Chiller compartment (including ice cube tray)
- 2 Drip tray
- 3 Temperature control
- 4 Glass shelves (3x)
- 5 Crisper drawer
- 6 Levelling feet (2x)
- 7 Door racks (3x)

B Documentation (not shown)

Instruction manual
Quick start guide
Warranty certificate

Getting Started

Unpacking

- **Packaging materials:** This product has been packaged to protect it against transportation damage. Remove all packaging materials from around and inside the appliance and keep the original packaging carton and materials in a safe place. It will help prevent any damage if the product needs to be transported in the future, and you can use it to store the appliance when it is not in use. In the event that the carton is to be disposed of, please recycle all packaging materials where possible. Plastic wrapping can be a suffocation hazard for babies and young children, so ensure all packaging materials are out of their reach and disposed of safely.
- **Parts:** Check to ensure you have all the parts pictured opposite.
- **Power cord:** Unwind the power cord to its full length and inspect it for damage. Do not use the appliance if the appliance or its cord have been damaged or are not working properly. **In case of damage, contact our after sales support line for advice on examination, repair or return of the damaged product.**
- **Clean:** Make sure the bar fridge is disconnected from the power supply before cleaning the interior surfaces and all internal accessories with lukewarm water, a soft cloth and a neutral/mild soap/detergent. This will remove any dust from transit and storage and help remove the typical smell of a brand new product. Then dry thoroughly. **Important:** do not use harsh or abrasive detergents or powders as these will damage the finish.
- **Door opening:** Your bar fridge has the capability of the door opening from the right or left side. If your set-up requires reversal of the door swing, follow the instructions on pages 18-19. Your new bar fridge is now ready for installation.

Installing the bar fridge

- **Safety first:** Before installing your new bar fridge, read all safety instructions in this manual, especially the sections on electrical safety and installation on page 6. Then follow the instructions below.
- **Keep it upright:** Do not tilt the bar fridge more than 45° from upright when moving it.
- **Freestanding design:** This appliance is designed to be freestanding only and should not be recessed or built in.
- **Handle with care:** Do not apply force to any part such as the condenser or door.
- **Floor surface:** Place the bar fridge on a sturdy, level floor that is strong enough to support the unit when it is fully loaded.
- **Levelling:** To level the bar fridge, adjust the levelling legs at the bottom of the unit.
- **Door opening:** Ensure there are no obstructions that could prevent the fridge door from closing.

Getting Started (Cont.)

- **Clearances:** Allow at least 10cm clear space between the back and sides of the unit and your wall or another appliance to ensure proper air circulation, which is necessary to allow for the cooling of the compressor and condenser (Fig.1).

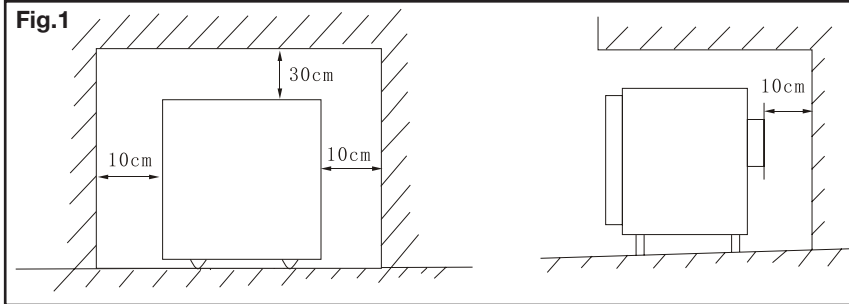

- **Location:** Locate the bar fridge:
 - Away from direct sunlight, which may affect the coating.
 - Away from sources of heat (stove, heater, radiator, etc.), which may increase power consumption.
 - In an area without extreme cold ambient temperatures, which may affect cooling performance.
 - In an area without excessive moisture and high humidity.
- **Enhancing energy efficiency:** Installing the unit in the coolest area of the room will save energy consumption and running costs.
- **Before plugging in your new bar fridge, let it stand upright for approximately 2 hours.** This will allow the refrigerant gases to settle into the compressor and reduce the possibility of a malfunction in the cooling system from handling during transportation.
- **Electrical connection:** Plug the unit into an exclusive, properly installed and earthed wall outlet. Do not under any circumstances cut or remove the third (ground) prong from the power cord. If in doubt about your setup, direct any questions concerning power and/or grounding to a certified electrician.
- **Power cord:** Secure the bar fridge's supply cord behind the unit. Do not leave it exposed or dangling to prevent injury and accidental disconnection from the power supply.
- **Plug the appliance into a wall outlet and allow it to cool down for 2-3 hours on setting [7] before placing food in the refrigerator compartment.**

Instructions

Temperature control

- The control for regulating the temperature in the refrigerator compartment is located on the upper right hand side of the compartment (Fig.2). The higher the number on the dial, the colder the temperature in the refrigerator compartment.

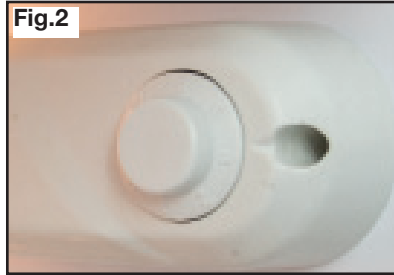

- The first time you turn the unit on, set the temperature control to the coldest position (7). After 24 to 48 hours, adjust it to the setting that best suits your needs – a middle setting (at position 3–4) should be appropriate in most cases for general operation.
- To turn the appliance off, first turn the temperature control to the minimum position, which will stop the cooling cycle, then disconnect the power supply cord from the wall outlet in order to shut off power to the unit.

NOTE: The unit may not work at the set temperature on particularly hot days, or if the door is opened too frequently. **To ensure efficient operation, do not open the door unnecessarily or for prolonged periods of time.**

NOTE: If the unit is unplugged, turned off or has lost power, you must wait 10 minutes before restarting the unit. If you attempt to restart before this time delay, the unit will not start.

Fresh food storage

- The refrigerator compartment is suitable for short-term storage of fresh food. The temperature inside varies depending on the amount of food stored and the frequency of door opening.
- In order to maintain good cooling efficiency and save energy, we recommend you do not open the door for too long or too often. Do not overload the bar fridge, and keep enough space around items for cold air flow. Do not block ventilation openings.
- The two full size glass shelves are adjustable to suit individual storage requirements (Fig.3).
- In order to keep vegetables fresh in the crisper, make sure they are properly packaged and the half size glass shelf sits firmly on top of the crisper drawer.

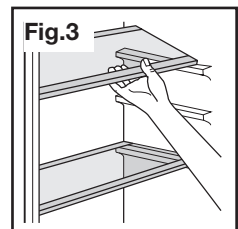

Instructions (Cont.)

Chiller compartment



- The chiller compartment (Fig.4) is not a true freezer. It is designed for the production of ice cubes and short-term storage (3-4 days at most) of some frozen foods. **The temperature in this compartment does not get cold enough to freeze food safely for long periods of time.** It works best when the food is already frozen.
- Do not store bottled beverages in the chiller compartment as liquids may expand when frozen causing the bottle to break and potentially damage the appliance.
- The door of the chiller compartment is susceptible to breaking due to excessive ice build-up. **This part is not covered under your warranty.** Be sure to defrost when the ice reaches about 3–4mm in thickness (see page 16 for defrosting instructions).

Ice cube tray

- Fill the ice cube tray two thirds full with cold water, or with any liquid suitable for freezing. The recommended thermostat setting for ice making is position [7].
- Wipe the bottom of the tray dry and place it on the bottom of the chiller compartment for freezing.
- To get the ice cubes out of the tray, hold the tray under cold tap water for a second, then place it over an ice bucket and twist slightly.
NOTE: Discard the first batch of ice cubes and clean and dry the ice cube tray thoroughly after use.
- Reset the temperature control to your usual setting after ice cube production.

Drip tray

- The drip tray is designed to catch melting ice during defrosting. It slides into the grooves underneath the chiller compartment. Empty any water out of the drip tray periodically. Then wash and dry it before placing it back.

Instructions (Cont.)

Energy saving tips

- Place the fridge in the coolest area of the room, away from heat-producing appliances and out of direct sunlight.
- Let hot foods cool to room temperature before placing them into the fridge. Overloading the fridge forces the compressor to run longer.
- Wrap foods properly and wipe containers dry before placing them in the fridge. This cuts down on frost build-up inside the fridge.
- Do not line any fridge storage bin with aluminum foil, wax paper or paper towels. Liners interfere with cold air circulation, reducing cooling efficiency.
- Position food so that air can circulate freely around it.
- Do not leave the fridge door open for longer than required.

Power failure

Most power failures are corrected within a few hours and should not affect the temperature inside your fridge, if you minimise the number of times the door is opened. However, if the power is going to be off for a longer period of time, you need to take proper steps to protect your food.

Going away?

- **Short vacation:** Leave the fridge operating during vacations of less than a month.
- **Long vacation:** If you are not going to use the bar fridge for longer periods, remove all food and unplug the power cord. Clean and dry the interior thoroughly. To prevent odour and mould growth, leave the door open slightly, blocking it open, if necessary. (Restrict children's access to the room with the open fridge to avoid creating a child entrapment risk.)

Moving the fridge

- Remove all food from inside the fridge, securely tape down the drawer and shelves and tape the door shut. Turn the levelling feet up to the base to avoid damage.
- Protect the outside of the unit with a blanket or similar soft material and make sure the fridge stays secure in the upright position during transportation.

FAQs and Troubleshooting Guide

If you experience a problem with your bar fridge, check in the following table for solutions to help you solve the problem. If after these checks you still have a problem with your bar fridge, contact our after sales support centre for advice.

Problem	Possible cause
The fridge does not operate.	<ul style="list-style-type: none"> • It is not plugged in. Ensure it is properly plugged in and there is power at the socket (plug another appliance into the outlet to check). • The circuit breaker tripped or has blown a fuse. • The fridge temperature control is set too warm. • A general power outage has cut power to your home (check the household lights).
The fridge turns on and off frequently.	<ul style="list-style-type: none"> • The room temperature is hotter than normal. • A large amount of food has been added to the fridge. • The door is opened too often. • The door is not closed completely. • The temperature control is not set correctly. • The door gasket does not seal properly. • The fridge does not have the correct clearances.
There are vibrations.	<ul style="list-style-type: none"> • The fridge is not level.
The fridge seems to make too much noise.	<ul style="list-style-type: none"> • The rattling noise may come from the flow of the refrigerant, which is normal. • As each cycle ends, you may hear gurgling sounds caused by the flow of refrigerant. • Contraction and expansion of the inside walls may cause popping and crackling noises. • The fridge is not level.
The door will not close properly.	<ul style="list-style-type: none"> • The fridge is not level. • The door was reversed and is not properly installed. • The gasket is dirty or bent. • The shelves, bins or baskets are out of position.
The fridge door will not open.	<ul style="list-style-type: none"> • If the door has just been opened, leave it for a few minutes to allow the air pressure to equalise before trying again.

FAQs and Troubleshooting Guide (Cont.)

<p>Moisture forms on the inside or outside walls of the bar fridge.</p>	<ul style="list-style-type: none"> • Hot and humid weather increases the internal rate of frost build-up. This is normal. • Open the door less often and make sure it is always properly closed.
<p>The external fridge surface is warm.</p>	<ul style="list-style-type: none"> • The exterior walls can be warmer than room temperature. This is normal while the compressor works to transfer heat from inside the fridge cabinet.
<p>Excessive frost and ice has built up.</p>	<ul style="list-style-type: none"> • The fridge door has been left open. • Something is preventing the door from closing. • The door gasket is dirty or damaged.
<p>The compressor runs continuously.</p>	<ul style="list-style-type: none"> • The temperature is set too cold: select a lower (warmer) setting. • The door is open, or something is obstructing proper door closure. • The door gaskets are worn, dirty or damaged. • Large quantities of food have been added to the fridge. • The room temperature is hotter than usual.

Other Useful Information

WARNING!

To reduce the risk of electric shock or injury, always switch off the appliance and disconnect it from the power supply before defrosting, cleaning or maintenance.

Defrosting the bar fridge

- For efficient operation and minimum energy consumption, defrost the bar fridge when the frost on the chiller compartment walls is building up; do not let frost build up to more than 3–4mm thickness.
- Turn the temperature control to the minimum position, unplug the appliance and remove frozen or perishable food items from the chiller compartment. Keep frozen food temporarily in another fridge or freezer to keep defrosting to a minimum.
- During the defrost cycle, the ice melts into the drip tray. To remove the water, either take out the drip tray and/or place a collection container under the tray, or use a sponge or towel to wipe the melting ice off the fridge floor.
- Defrosting usually takes a few hours. After defrosting, wipe the drip tray and chiller compartment dry. Place the drip tray back under the chiller compartment and return the thermostat dial to the desired position.
- To defrost quickly, remove all foods from the fridge and leave the door open. Place an old towel underneath the appliance to collect any spillage.

WARNING!

- Never use sharp or metallic tools to scrape off frost as it may damage the cooling system. To scrape ice off surfaces, use a plastic scraper.
- Do not use boiling water to accelerate defrosting because it may damage any plastic parts.

Cleaning the bar fridge

- Turn the temperature control to the minimum position, unplug the bar fridge and remove the food, shelves and tray.
- Wash the inside surfaces and the interior accessories with a damp, warm cloth moistened in a water and baking soda solution (about 2 tablespoons of baking soda to 1 litre of water). Wring excess water out of the cloth before cleaning around the temperature control or any electrical parts. Rinse and wipe dry with a soft cloth.
- Clean the outside of the unit with a damp, well wrung out cloth. Keep the door gasket (seal) clean.
- After everything is dry, place appliance back into service.

Other Useful Information (Cont.)

WARNING!

- Never clean the unit with an abrasive, acid, oil or solvent based cleaning agent, or with abrasive pads or scourers. Never use flammable fluids or sprays for cleaning as the fumes from these substances can create a fire hazard or explosion.
- Never clean the appliance with a steam cleaner. Moisture could accumulate in the electrical components, danger of electric shock! Hot vapours can lead to the damage of plastic parts.
- The appliance must be completely dry before it is placed back into service.

IMPORTANT!

- Ethereal oils and organic solvents can attack plastic parts, e.g. lemon juice or the juice from orange peel, butyric acid, or cleansers that contain acetic acid. Do not allow such substances to come into contact with the appliance parts.

Replacing the interior light

This fridge comes with a 10W interior light bulb. When replacing it make sure to use a bulb suitable for this purpose, of equivalent size and wattage and that the unit is disconnected from the power supply.

- First, remove the water drip tray for easier access to the lamp cover.
- To remove the lamp cover, first unscrew the screw using a Phillips head screwdriver. Then remove the plastic cover at the end of the thermostat enclosure by pushing both ends of the cover and pulling forward. Allow the cover to remain hinged on the rear side.
- Unscrew the light bulb, remove it and replace it with a new one of the same shape and wattage.
- Push the cover back into place and secure it with the screw.
- Replace the water drip tray.
- Connect the unit to power and set the temperature control to the usual setting.



Other Useful Information (Cont.)

Reversing the door swing

This bar fridge can be opened from either side to suit your individual installation requirements. If you want to open the door from the other side, follow the instructions below and on the following pages to reverse the door swing.

Tools required: Phillips head screwdriver, flat-bladed screwdriver, hexagonal spanner

Help required: We recommend you ask another person to help you during assembly.

- **WARNING!** Ensure the fridge is empty and disconnected from the power supply.
- Keep all parts you remove for re-installation of the door on the other side.
- Tilt the appliance slightly towards the back and prop it up securely on something solid so that it will not slip during the door reversing process. Do not lay the unit flat as this may damage the coolant system.

1. Remove the top right hinge cover (Fig.6).
2. Undo the screws, then remove the hinge bracket (Fig.7).

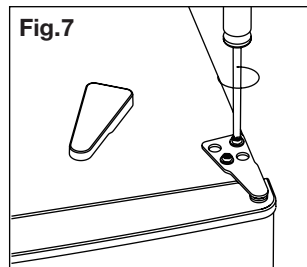
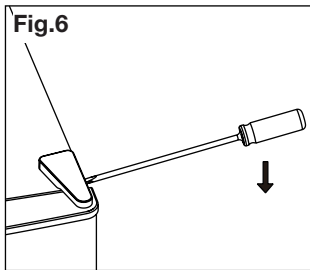

3. Remove the top left screw cover (Fig.8).
4. Move the core cover from the left to the right side (Fig.9). Lift the door and place it on a padded surface to prevent it from scratching.

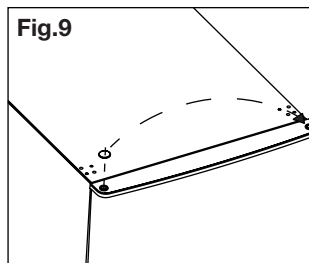
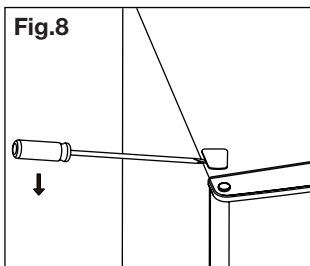

Other Useful Information (Cont.)

5. Unscrew the bottom hinge. Then remove the adjustable feet from both sides (Fig.10).

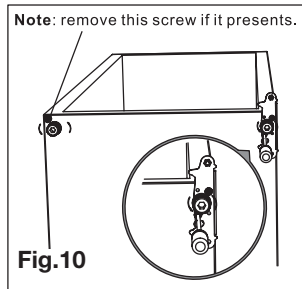

6. Unscrew and remove the bottom hinge pin, turn the bracket over and replace it (Fig.11).

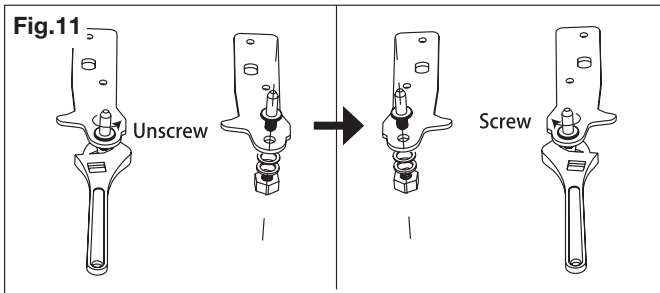

7. Refit the bracket fitting the bottom hinge pin. Replace both adjustable feet (Fig.12).
8. Reattach the door, making sure it is aligned horizontally and vertically so the seals are closed on all sides before finally tightening the top hinge (Fig.13). Insert the hinge bracket and screw it to the top of the unit. Use a spanner to tighten, if necessary.
9. Reattach the hinge cover and the screw cover (Fig.14).

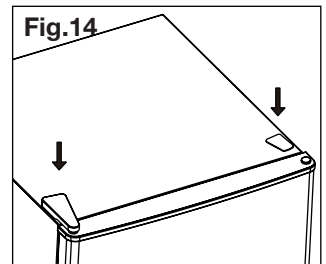
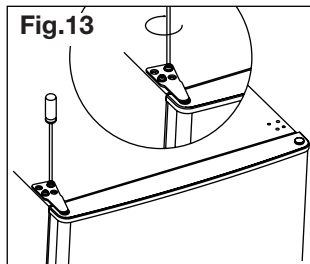
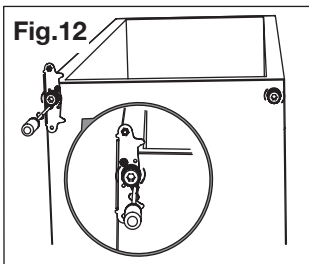

Other Useful Information (Cont.)

Service and repair

Do not attempt to alter or modify this appliance in any way.

Do not attempt to repair or replace any part of the appliance unless it is specifically recommended in this manual. All other servicing should be referred to a qualified technician. Contact our after sales support line for advice.

Spare parts

Our after sales support centre stocks the following spare parts for the STIRLING 129L Bar Fridge. To purchase a part, call the centre on 1300 886 649 or email us at info@tempo.org

- Adjustable feet (short and long)
- Chiller compartment door
- Crisper drawer
- Crisper cover
- Door rack (upper and lower)
- Door gasket
- Lamp bulb and cover
- Glass shelf
- Thermostat

Technical specifications

Rated voltage	220–240VAC
Rated frequency	50Hz
Rated current	0.55A
Climate class	T
Dimensions (mm)	840 (H) x 500 (W) x 560 (D)
Capacity	129L gross, 127L net
Refrigerant	R600a (29g)
Insulation blowing agent	Cyclopentane
Weight	25kg

Compliance

This product complies with the following standards:

- AS/NZS 60335.1 and AS/NZS 60335.2.24 for **electrical safety**
- AS/NZS 4474.1 and AS/NZS 4474.2 for **energy consumption**
- EN 55014.1 and EN 61000.3.3 for **electromagnetic compatibility**

Other Useful Information (Cont.)

Responsible disposal

- At the end of its working life, do not throw this appliance out with your household rubbish. Electrical and electronic products contain substances that can have a detrimental effect on the environment and human health if disposed of inappropriately. Observe any local regulations regarding the disposal of electrical consumer goods and dispose of it appropriately for recycling and recovery of the refrigerant and blowing agent. Contact your municipal authorities for advice on recycling facilities in your area.
- This refrigeration appliance contains flammable refrigerants and insulation blowing gases, which must be removed before disposal. Contact your municipal authorities for any codes or regulations concerning the disposal of such materials.
- **DANGER! Risk of child entrapment:** When discarding the fridge, make sure to take off the door and leave the shelves in place so that children cannot easily climb in and get trapped inside.

This page has been left blank intentionally.



STIRLING[®]

129L Bar Fridge

Repair and Refurbished Goods or Parts Notice

Unfortunately, from time to time, faulty products are manufactured which need to be returned to the supplier for repair.

Please be aware that if your product is capable of retaining user-generated data (such as files stored on a computer hard drive, telephone numbers stored on a mobile telephone, songs stored on a portable media player, games saved on a games console or files stored on a USB memory stick) during the process of repair, some or all of your stored data may be lost. **We recommend you save this data elsewhere prior to sending the product for repair.**

You should also be aware that rather than repairing goods, we may replace them with refurbished goods of the same type or use refurbished parts in the repair process.

Please be assured though, refurbished parts or replacements are only used where they meet ALDI's stringent quality specifications.

If at any time you feel your repair is being handled unsatisfactorily, you may escalate your complaint. Please telephone us on 1300 886 649 or write to us at:

Tempo (Aust) Pty Ltd ABN 70 106 100 252
PO BOX 6056 Frenchs Forest, Sydney, Australia NSW 2086
Telephone: 1300 886 649 (Aust) - Fax: (02) 9975 2688
Tempo Help Desk: 1300 886 649 (Aust)
(Operating Hours: Mon-Fri 08:30am to 06:00pm EST)
Email: info@tempo.org





Warranty returns

Should you for any reason need to return this product for a warranty claim, make sure to include all accessories with the product.

Product does not work?

If you encounter problems with this product, or if it fails to perform to your expectations, make sure to contact our After Sales Support Centre on 1300 886 649 before returning it to the store for a refund.

For an electronic copy of this manual, go to www.stirlingappliances.com.au and download a copy.

Instruction Manual Revision Index

Version No	Issue Date	Description
V1.0	13 July 2015	Original release
V1.1	23 July 2015	Minor updates
V1.2	03 August 2015	Minor update (page 23)